

PVE52



Carico massimo
238 kg



Panoramica
a 360°



Design Unico



Ascensori
a Vuoto



Installazione
rapida (in 2-3 giorni)



Plug&Play
Vtaggio a 220v



Finiture
Personalizzate



Minima
Manutenzione



Prodotto
Ecosostenibile



Installazione
senza Fossa



Massima
Sicurezza



Generali

Diametro esterno del cilindro (mm)	1316
Carico massimo (kg)	238
Velocità	<0.15m/s
N° fermate	da 2 a 5
Percorso massimo (m)	15

Porte

Carichi disponibili	0° e 180°
Cerniere standard (dall'esterno)	Destra
Cerniere opzionali (dall'esterno)	Sinistra
Possibilità porta automatica	Sì
Altezza porta (mm)	2024
Altezza fino alla parte superiore chiudiporta (mm)	2078

Cabina

Altezza interna cabina (mm)	2010
Diametro interno (mm)	
senza colonne	1210
tra colonne	1096
Larghezza ingresso porta (mm)	813
Circuito elettrico di controllo cabina	24V
Pulsante automatico one-touch	Sì
Sedia pieghevole in cabina	No
Accessibile su sedia a rotelle	Sì

Sicurezza









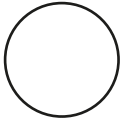

Discesa automatica in mancanza di elettricità	Sì
Frenata di emergenza	Sì
Sistema limite di sovraccarico	Sì
Pulsante di allarme	Sì
Telefono	Sì
Sistema di ancoraggio meccanico su ciascun piano	Sì

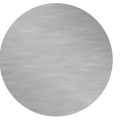
Requisiti di Installazione

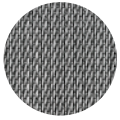
Diametro di foratura/foro libero (mm)	1389
Altezza minima all'ultimo piano (mm)	2450
Pavimento livellato	Sì

Elettricità/Alimentazione

Fornitura	Linea monofase 220V a 3 (Fase, Neutro, Terra) x 10mm (sezione di ciascun cavo)
Potenza massima	6kW
Protezione richiesta	Differenziale e Magnetotermico di 32A

	Colori Struttura	Pavimento Cabina	Finiture Tetto
Colori Standard	 Bianco	 Marrone Dorato	 Spazzolato
	 Grigio bluastro	 Metallico	 Specchio
	 Grigio Perla	 Nero	
Colori Speciali	 Nero Mat		
	 Argento		
	 Bronzo		

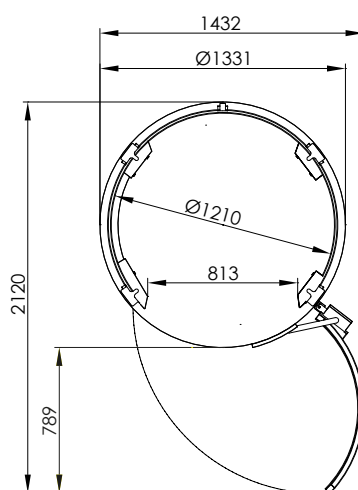

OPZIONI DI CARICO

